

Features

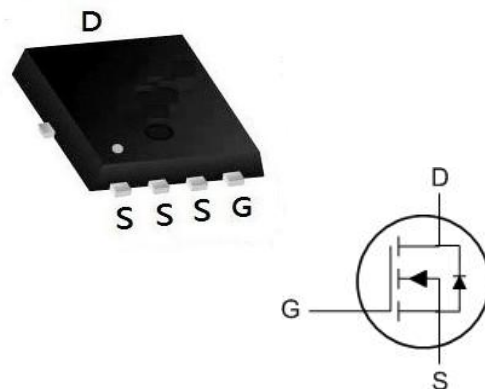
- Split Gate Trench MOSFET technology
- Excellent package for heat dissipation
- High density cell design for low $R_{DS(ON)}$


Product Summary

BVDSS	RDSON	ID
100V	7.9mΩ	60A

Applications

- DC-DC Converters
- Power management functions
- Synchronous-rectification applications

PDFN5060-8L Pin Configuration

Absolute Maximum Ratings (T_A = 25°C, unless otherwise noted)

Parameter		Symbol	Value	Unit
Drain-Source Voltage		V_{DS}	100	V
Gate-Source Voltage		V_{GS}	±20	V
Continuous Drain Current	T _C =25°C	I_D	60	A
	T _C =100°C		28.5	
Pulsed Drain Current ¹		I_{DM}	180	A
Single Pulse Avalanche Energy ²		EAS	80	mJ
Total Power Dissipation	T _C =25°C	P_D	67.5	W
Operating Junction and Storage Temperature Range		T_J , T_{STG}	-55 to 150	°C

Thermal Characteristics

Parameter	Symbol	Value	Unit
Thermal Resistance from Junction-to-Ambient ³	R_{θJA}	45	°C/W
Thermal Resistance from Junction-to-Lead	R_{θJC}	1.85	°C/W

Electrical Characteristics (T_J = 25°C, unless otherwise noted)

Parameter	Symbol	Test Conditions	Min.	Typ.	Max.	Unit	
Static Characteristics							
Drain-Source Breakdown Voltage	V_{(BR)DSS}	V _{GS} = 0V, I _D = 250μA	100	-	-	V	
Gate-Body Leakage Current	I_{GSS}	V _{DS} = 0V, V _{GS} = ±20V	-	-	±100	nA	
Zero Gate Voltage Drain Current	I_{DSS}	V _{DS} = 100V, V _{GS} = 0V	T _J =25°C	-	-	1	μA
			T _J =100°C	-	-	100	
Gate-Threshold Voltage	V_{GS(th)}	V _{DS} = V _{GS} , I _D = 250μA	1	1.7	2.5	V	
Drain-Source on-Resistance ⁴	R_{DS(on)}	V _{GS} = 10V, I _D = 20A	-	7.9	10	mΩ	
		V _{GS} = 4.5V, I _D = 10A	-	-	-		
Forward Transconductance ⁴	g_{fs}	V _{DS} = 10V, I _D = 20A	-	54	-	S	
Dynamic Characteristics⁵							
Input Capacitance	C_{iss}	V _{DS} = 50V, V _{GS} = 0V, f = 1MHz	-	1208	-	pF	
Output Capacitance	C_{oss}		-	144	-		
Reverse Transfer Capacitance	C_{rss}		-	11.3	-		
Gate Resistance	R_G	f = 1MHz	-	1.8	-	Ω	
Switching Characteristics⁵							
Total Gate Charge	Q_g	V _{GS} = 10V, V _{DS} = 50V, I _D = 20A	-	22.7	-	nC	
Gate-Source Charge	Q_{gs}		-	3	-		
Gate-Drain Charge	Q_{gd}		-	5	-		
Turn-on Delay Time	t_{d(on)}	V _{GS} = 10V, V _{DD} = 50V, R _G = 3Ω, I _D = 20A	-	9.2	-	ns	
Rise Time	t_r		-	3.6	-		
Turn-off Delay Time	t_{d(off)}		-	25.6	-		
Fall Time	t_f		-	4.4	-		
Body Diode Reverse Recovery Time	t_{rr}	I _F = 20A, di/dt = 100A/μs	-	30	-	ns	
Body Diode Reverse Recovery Charge	Q_{rr}		-	42	-	nC	
Drain-Source Body Diode Characteristics							
Diode Forward Voltage ⁴	V_{SD}	I _S = 20A, V _{GS} = 0V	-	-	1.2	V	
Continuous Source Current	I_S	T _C =25°C	-	-	60	A	

Notes:

1. Repetitive rating, pulse width limited by junction temperature T_{J(MAX)}=150°C.
2. The EAS data shows Max. rating . The test condition is V_{DD}=25V, V_{GS}=10V, L=0.4mH, I_{AS}=20A.
3. The data tested by surface mounted on a 1 inch² FR-4 board with 2OZ copper, The value in any given application depends on the user's specific board design.
4. The data tested by pulsed , pulse width ≤ 300us , duty cycle ≤ 2%.
5. This value is guaranteed by design hence it is not included in the production test..

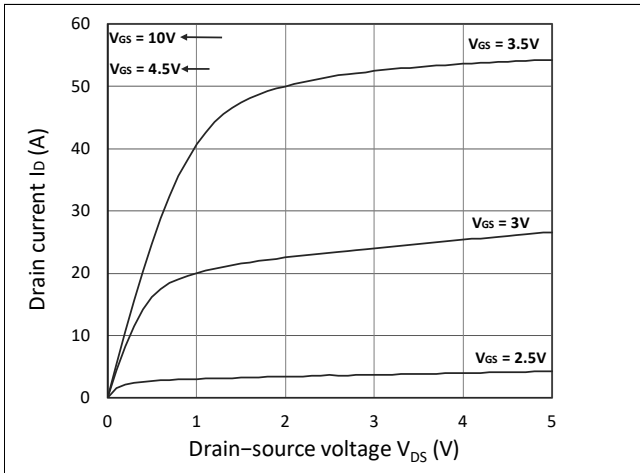
Typical Characteristics


Figure 1. Output Characteristics

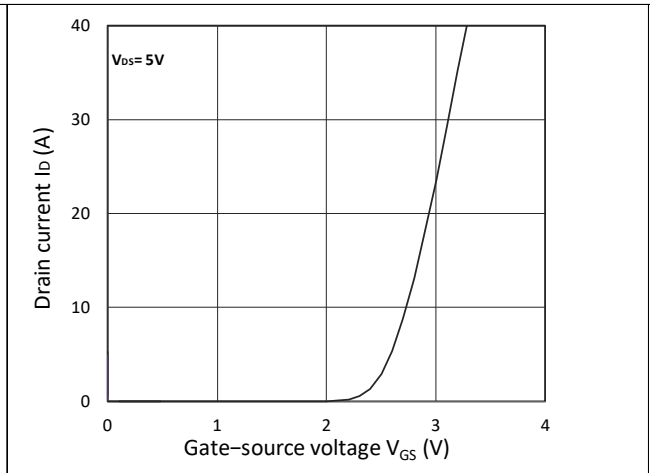


Figure 2. Transfer Characteristics

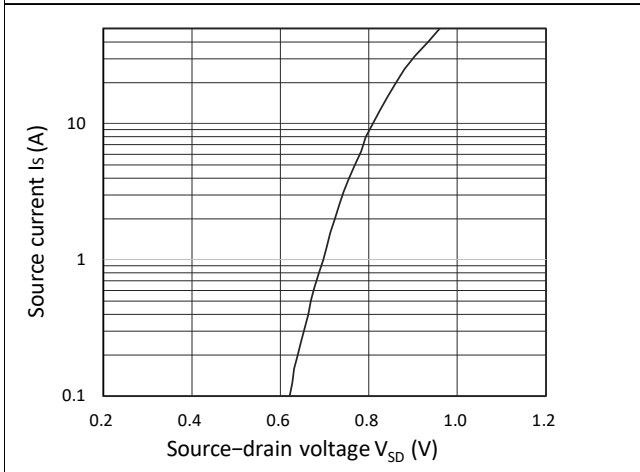
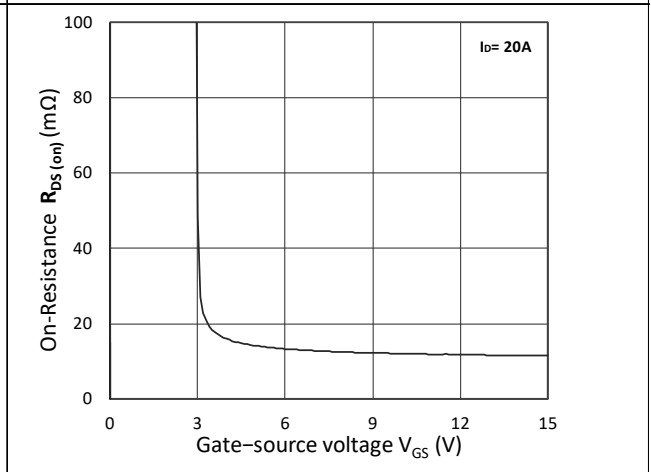
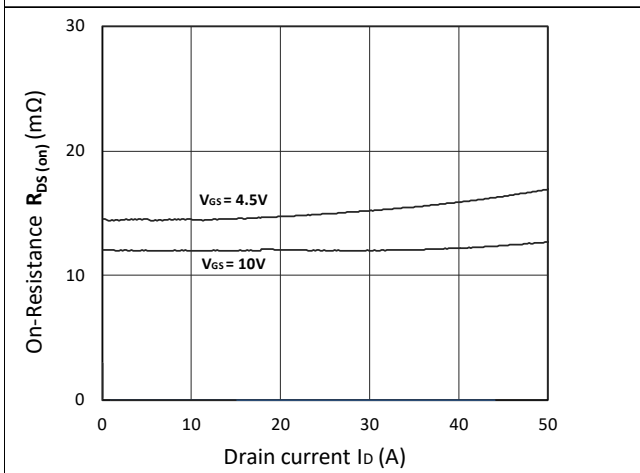
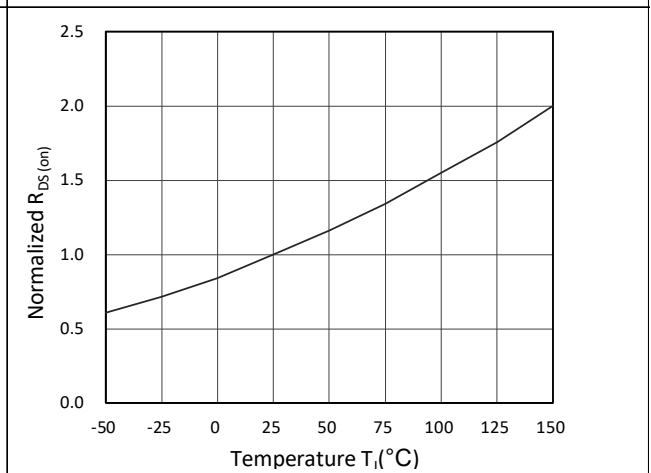


Figure 3. Forward Characteristics of Reverse


 Figure 4. $R_{DS(on)}$ vs. V_{GS}

 Figure 5. $R_{DS(on)}$ vs. I_D

 Figure 6. Normalized $R_{DS(on)}$ vs. Temperature

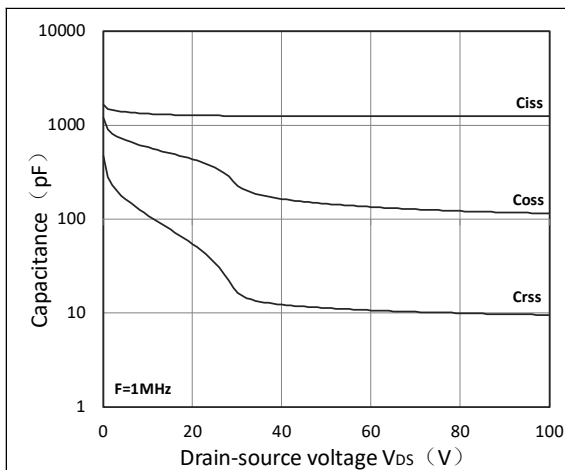
N-Ch 100V Fast Switching MOSFETs


Figure 7. Capacitance Characteristics

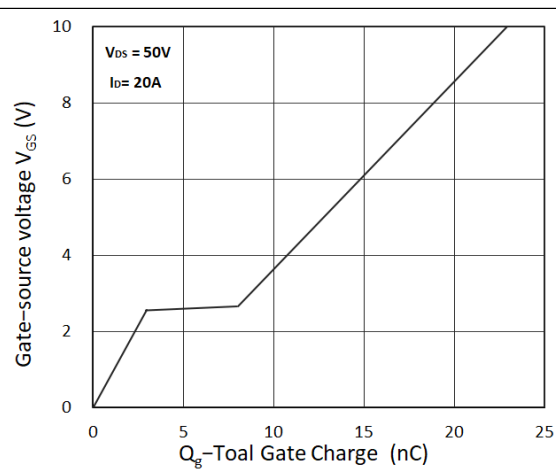


Figure 8. Gate Charge Characteristics

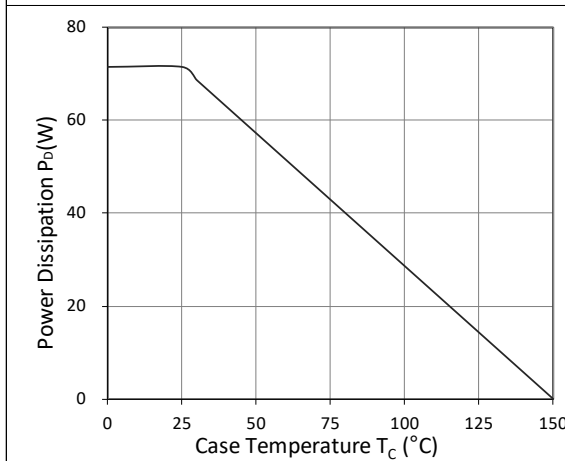


Figure 9. Power Dissipation

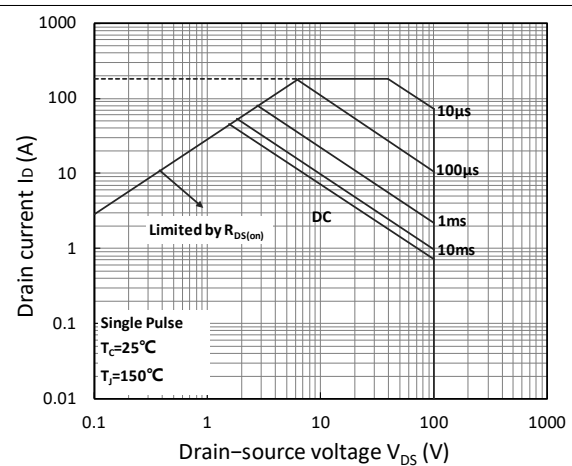


Figure 10. Safe Operating Area

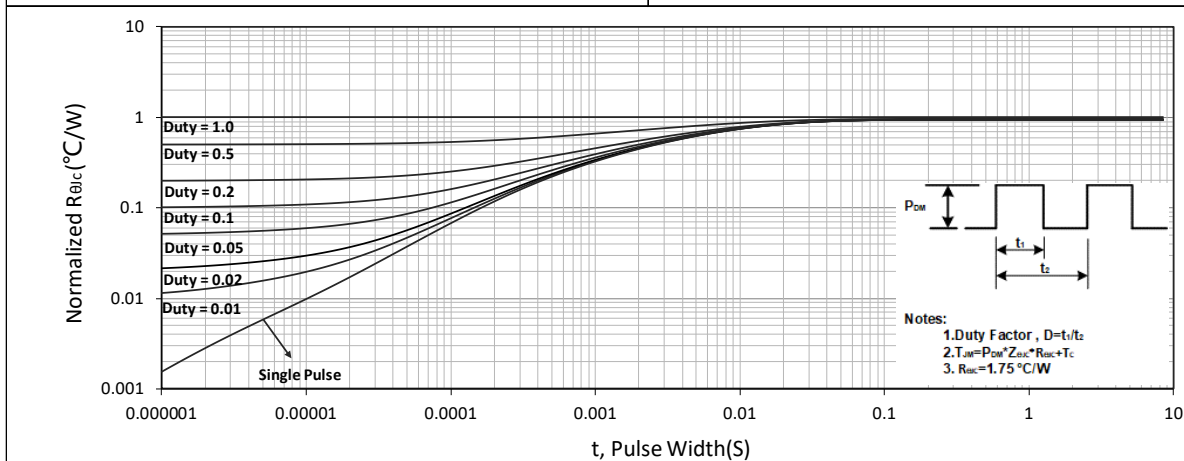


Figure 11. Normalized Maximum Transient Thermal Impedance

Test Circuit

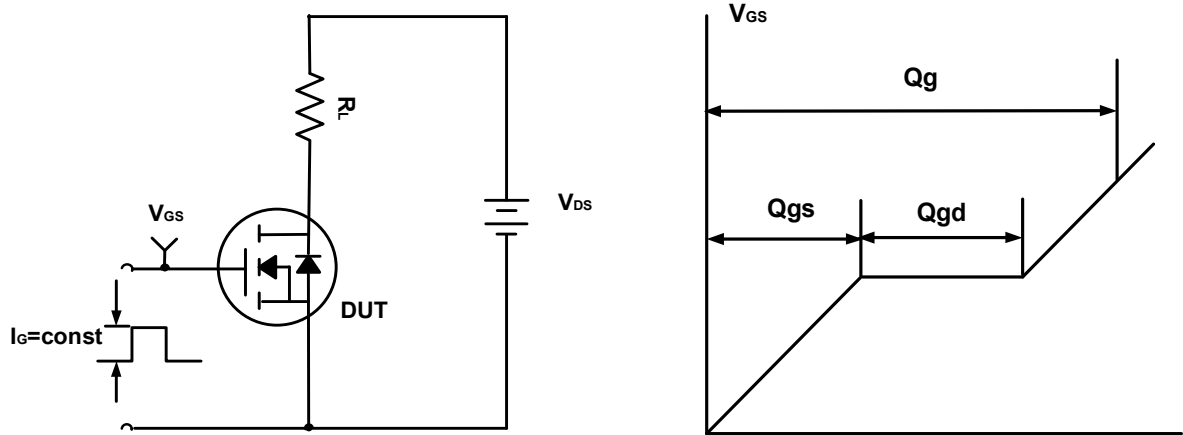


Figure A. Gate Charge Test Circuit & Waveforms

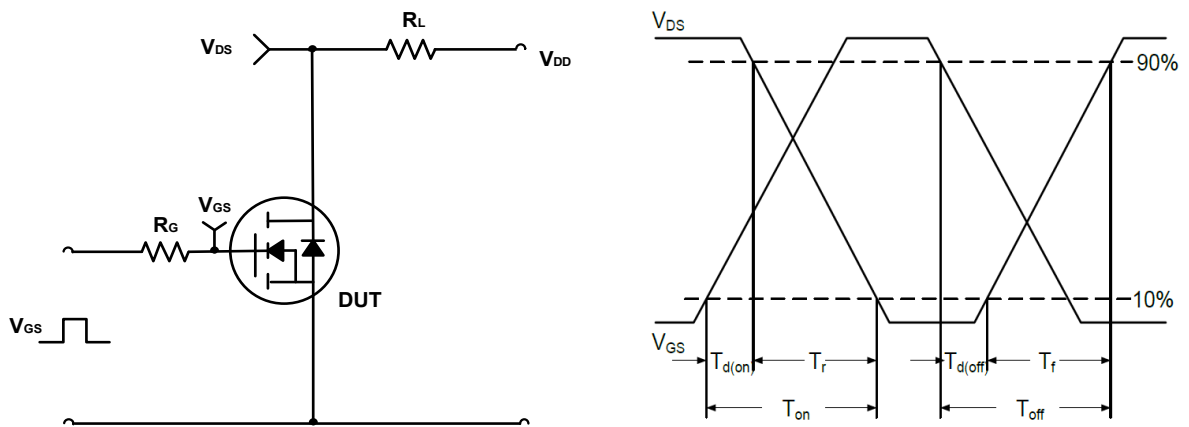


Figure B. Switching Test Circuit & Waveforms

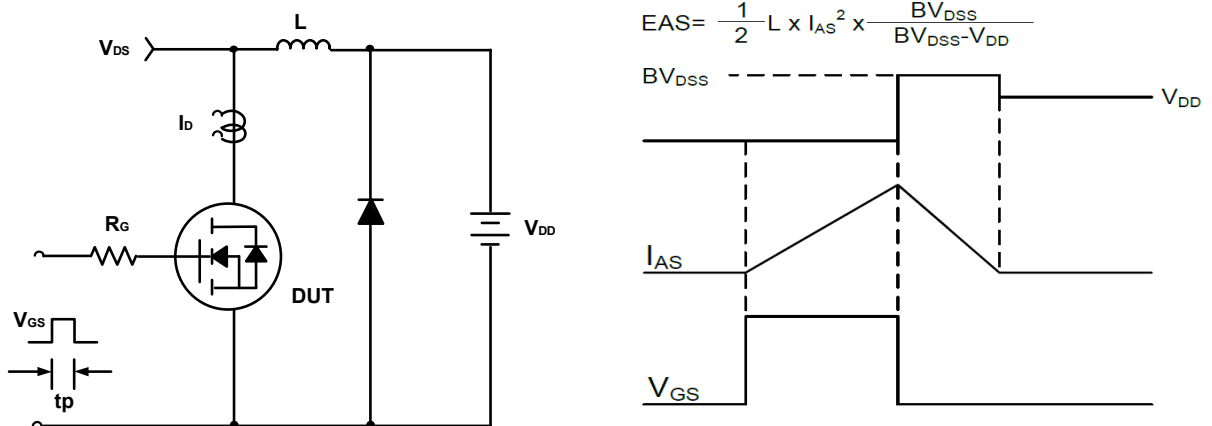
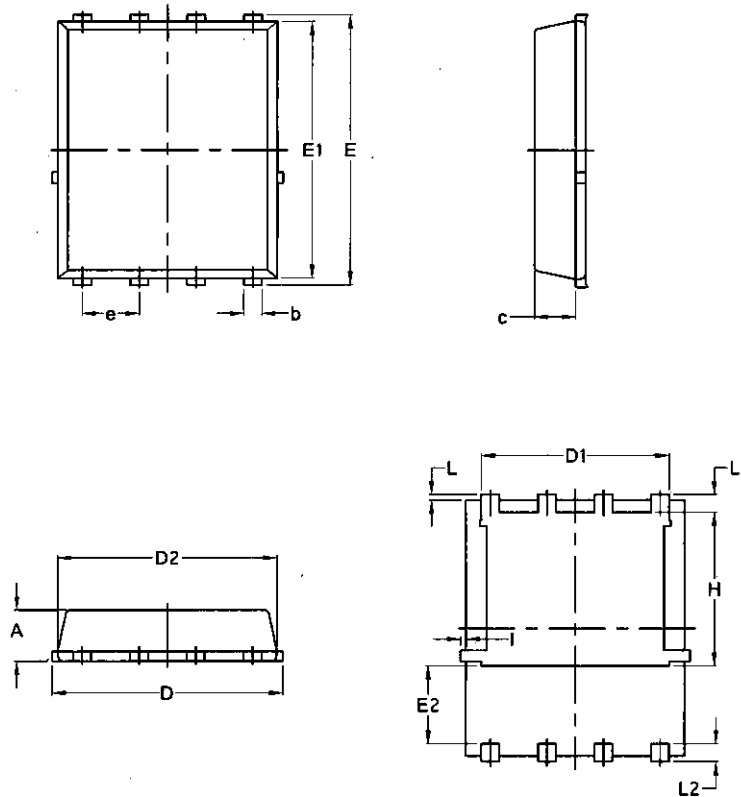


Figure C. Unclamped Inductive Switching Circuit & Waveforms

Package Mechanical Data-PDFN5060-8L -Single


Symbol	Common			
	mm		Inch	
	Mim	Max	Min	Max
A	1.03	1.17	0.0406	0.0461
b	0.34	0.48	0.0134	0.0189
c	0.824	0.0970	0.0324	0.082
D	4.80	5.40	0.1890	0.2126
D1	4.11	4.31	0.1618	0.1697
D2	4.80	5.00	0.1890	0.1969
E	5.95	6.15	0.2343	0.2421
E1	5.65	5.85	0.2224	0.2303
E2	1.60	/	0.0630	/
e	1.27 BSC		0.05 BSC	
L	0.05	0.25	0.0020	0.0098
L1	0.38	0.50	0.0150	0.0197
L2	0.38	0.50	0.0150	0.0197
H	3.30	3.50	0.1299	0.1378
I	/	0.18	/	0.0070